

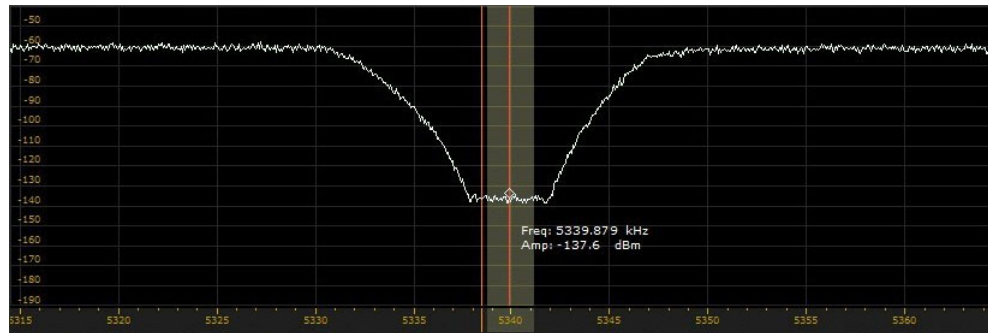

Perseus

Direct-Sampling SDR HF Receiver



Adam Farson VA7OJ

Why "Perseus"?



- Manufactured by Microtelecom s.a.r.l., Pavia di Udine, Italy
- One interpretation (from a Microtelecom brochure):
 - ◆ "Pretty Excellent Receiver for Software-Eager Unperceivable Signals"

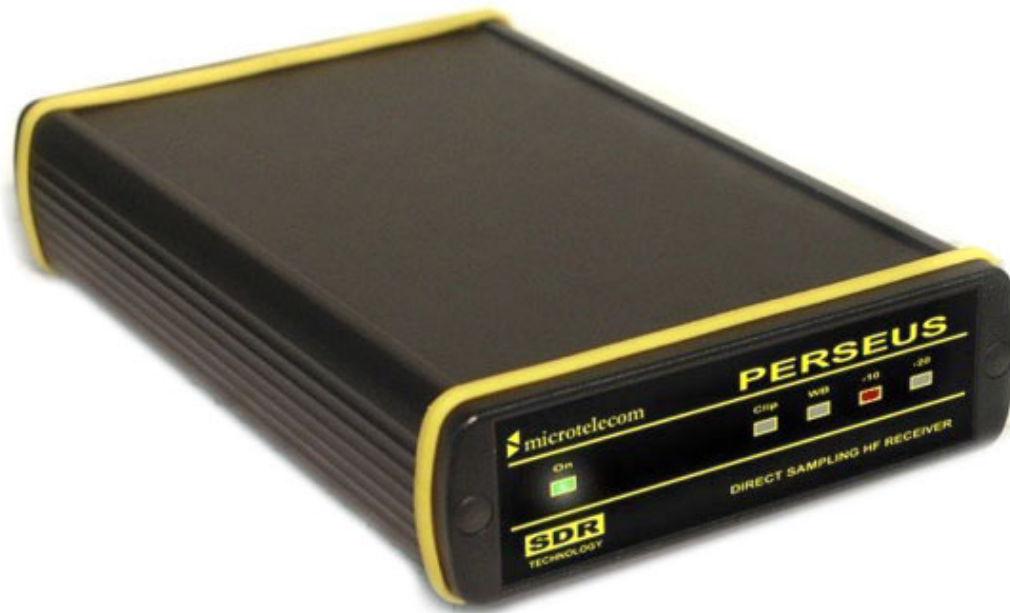

What the Perseus does



— • — • — • — • • • — • — • • • — • • • • — •

■ The Perseus is:

◆ a “radio”

- ▶ a high-performance LF/MF/HF receiver

◆ a test instrument

- ▶ an affordable spectrum analyzer
- ▶ an accurate selective RF power meter

■ It is not:

◆ a transceiver

- ▶ it has no transmit capability

Front Panel



- **Clip:** ADC clipping (full-scale, 0 dBFS)
- **WB:** Wideband (preselector out)
- **-10, -20:** Attenuator value in dB

Rear Panel



 **The Perseus must be powered *only* with the supplied PSU.**

Interior View



ADC DDC USB Controller

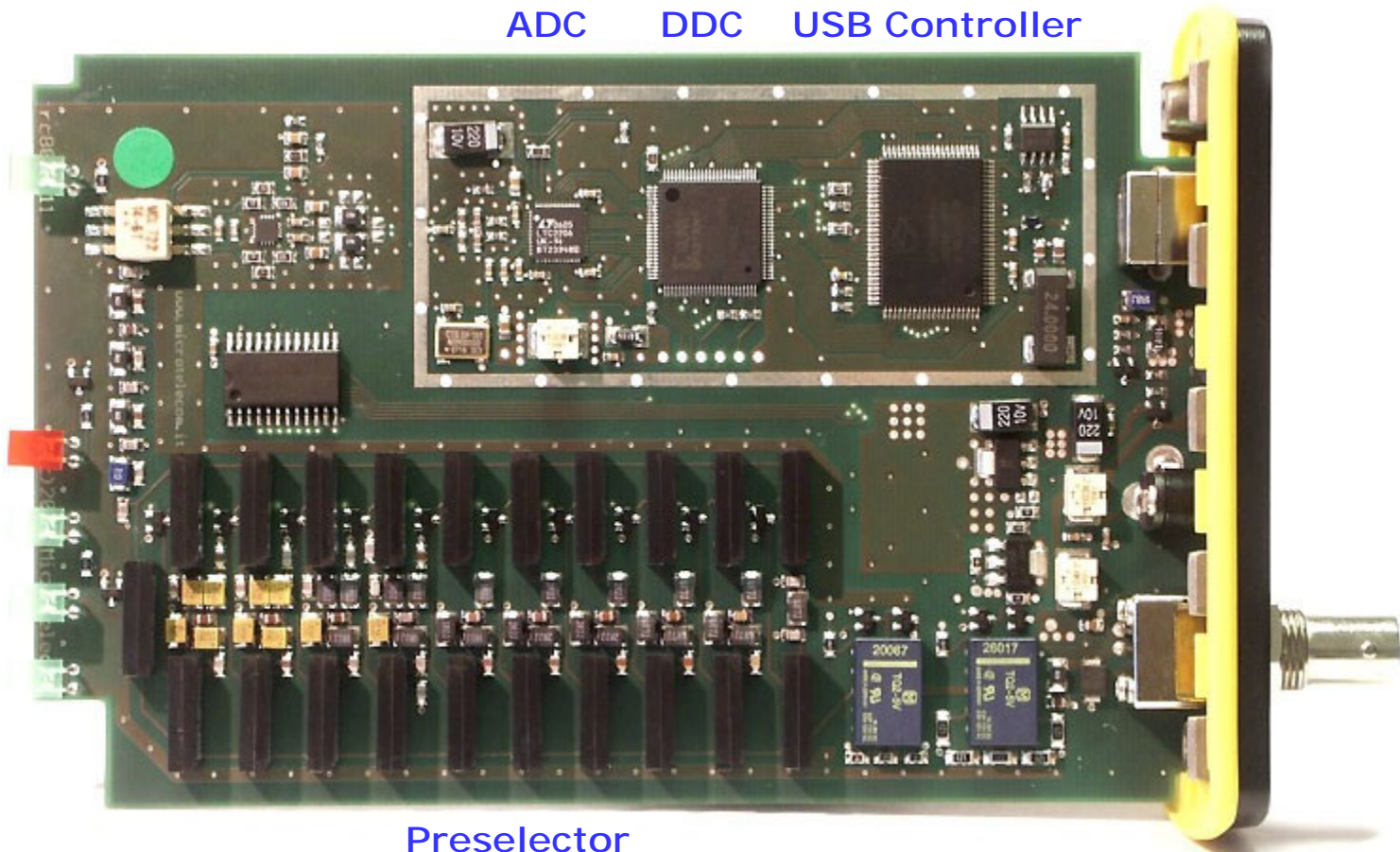

Preselector

Block Diagram

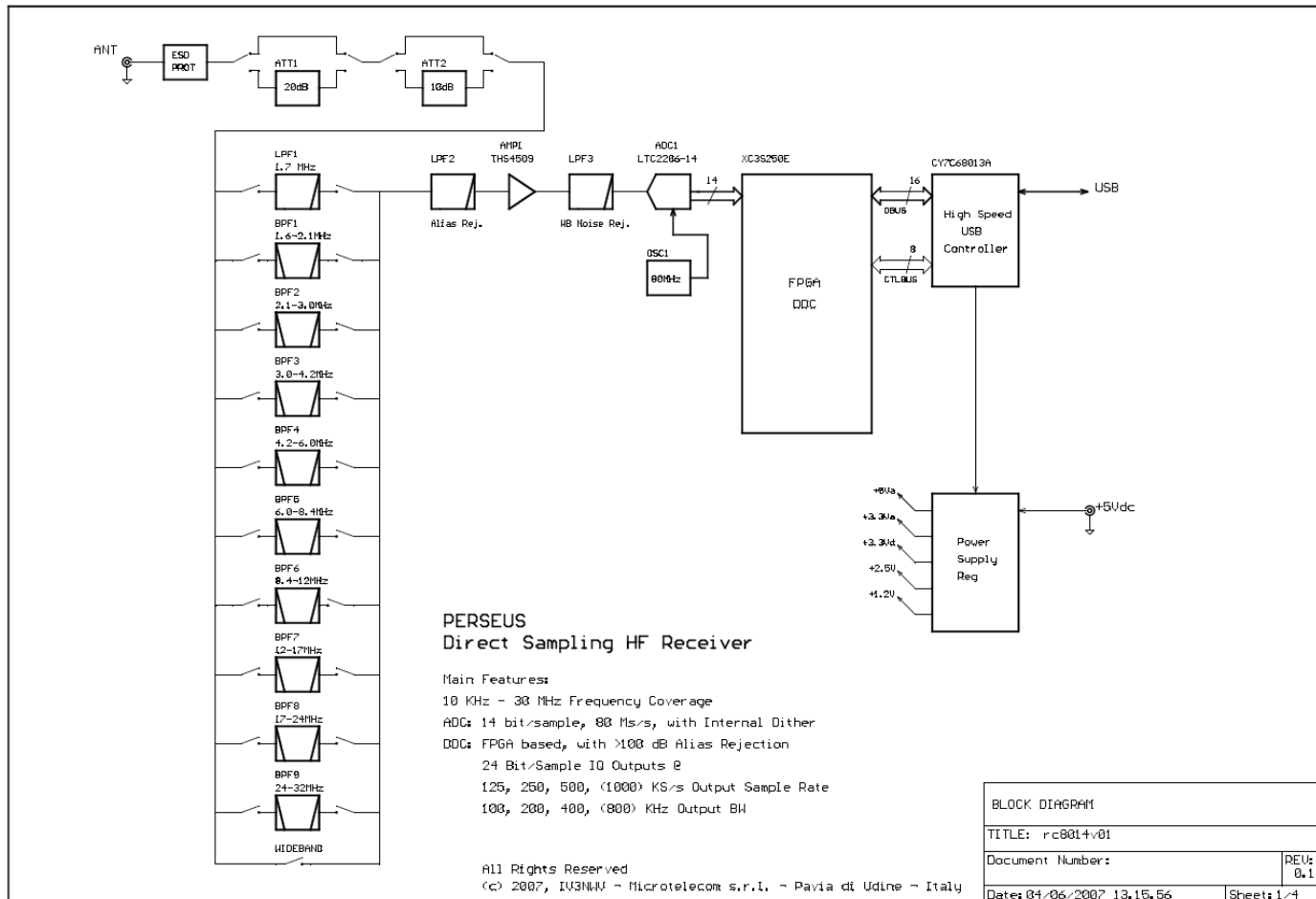

Perseus Spec Sheet



- **Frequency range:** 10 KHz - 30 MHz
- **Modes:** USB, LSB, CW, AM, FMN, FSK, DRM, etc. as defined by software
- **Sensitivity:** 0.39 μ V SSB (S+N)/N= 10 dB*
- **MDS:** -124 dBm (SSB, 2.4Khz BW)*
- **Selectivity:** Defined by the PC software
- **Rejection:** 90 dB*
- **IP3:** 31 dBm*
- **Dynamic Range:** 103 dB (SSB, 2.4 kHz BW)*, 107 dB (CW, 500 Hz BW)*
- **Blocking:** 125 dB* -131 dBm (CW, 500Hz BW)*
- **ADC clipping level:** -3 dBm (preamp off), -6 dBm (preamp on)
- **Output sampling rate:** 100/200/400kHz I&Q signals
- **Preselector:** 1 x 3-pole LPF (0 - 1,7 MHz); 9 x 6-pole BPF (1,7 - 30 MHz)
- **Attenuator:** 0, 10, 20, 30 dB
- **ADC:** LTC 2206-14, 14-bit, 80Ms/s
- **DDC:** XC3S250E FPGA
- **PC interface:** USB 2.0 480 Mbit/s (cable included)
- **Power supply:** +5Vdc +/-5% 1 A (120 – 240V PSU included)
- **Cabinet:** Aluminum, 110 x 36 x 185 mm (W x H x D)

- **Typical at. 14.2 MHz*

Definition of an SDR



- • — • — • — • • • — • — • • • — • • • • — •
- A software-defined radio system, or SDR, is a radio communication system in which components previously implemented in hardware are now implemented by means of software on an external computer or on embedded computing devices.
 - ◆ Such components include mixers, filters, amplifiers, modulators/demodulators, detectors, etc.
 - The PERSEUS meets this definition, as all its functions except RF signal management (preselector, preamplifier and attenuator) are implemented in on-board firmware and in software running on an associated PC.

Why direct sampling?



- In a direct sampling SDR, the ADC (analogue to digital converter) samples the incident RF directly.
- The RF front end presents the entire HF range, or a portion thereof, to the ADC.
 - ◆ **The preselector band-limits the RF signal to increase the usable dynamic range of the ADC.**
- The digitized RF signal is digitally down-converted to a baseband (“zero IF”) which is presented to the PC via a USB link.
- The PERSEUS software performs all subsequent signal-processing and demodulation functions; the PC sound-card passes the demodulated audio to the speakers.

Digital down-converter (DDC)

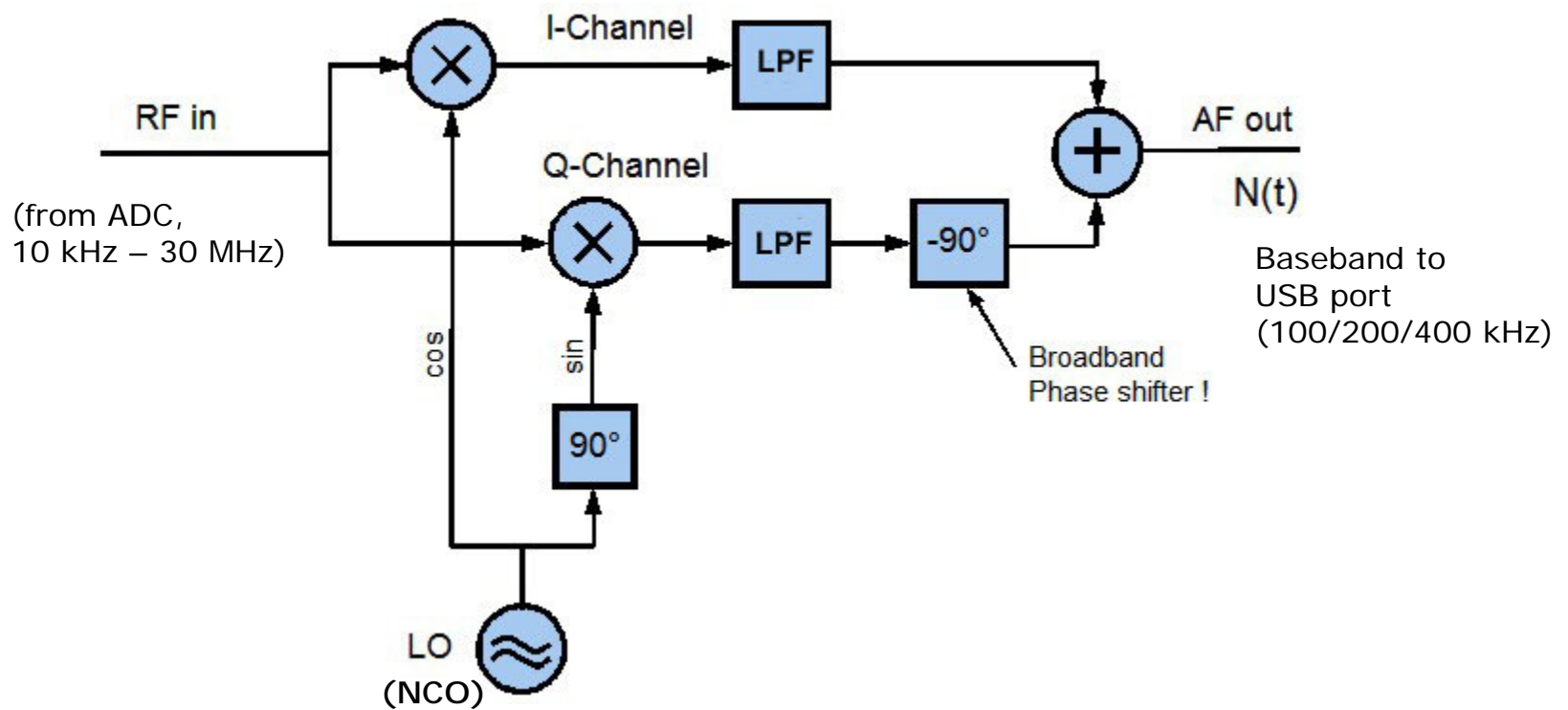

The magic of processing gain: "dynamic range from thin air"

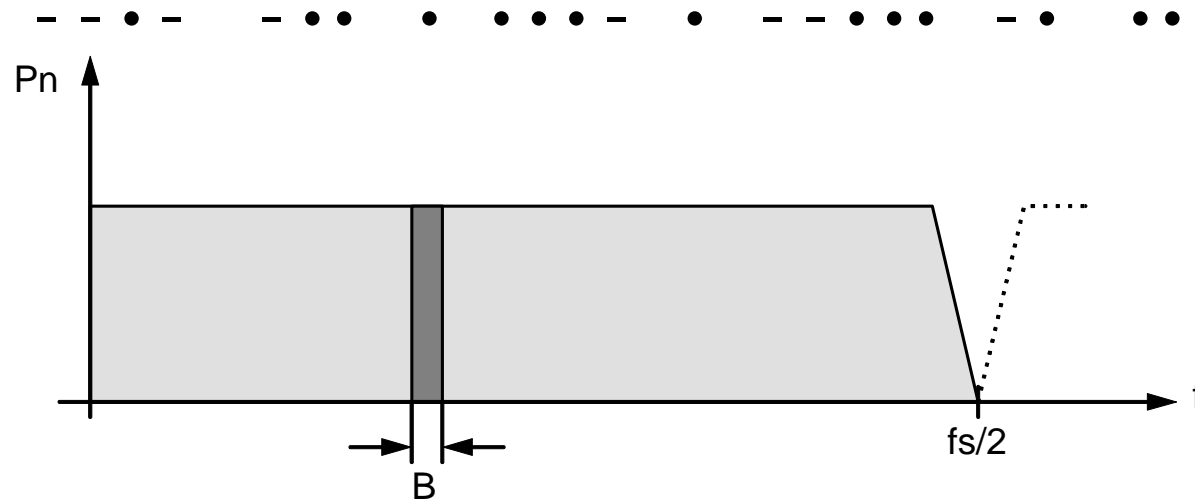

- Processing Gain $G_p = 10 \log_{10} (f_s / 2B)$
 - ◆ where f_s = sampling frequency and B = user channel bandwidth
- If $f_s = 80$ MHz and $B = 2.4$ kHz (SSB), then
$$G_p = 10 \log_{10} (80 \cdot 10^3 / 4.8) \approx 42 \text{ dB}$$
- For 14-bit ADC, theoretical dynamic range = $(14 \cdot 6) + 1.76 \approx 86$ dB
- Thus, theoretical system dynamic range = $86 + 42 = 128$ dB

ENOB (Equivalent Number of Bits) and Noise Floor



- Theoretical dynamic range of ADC = $20 \log 2^n$
 - ◆ where n = number of bits
- For LTC2206-14 ADC in Perseus, $20 \log 2^{14} \approx 84$ dB
- But **nothing** is perfect!
 - ◆ From data sheet, ADC S/N ratio ≈ 76 dB
 - ◆ This equates to 12.7 bits, i.e. ENOB ≈ 13
- So now our system dynamic range is $76 + 42 = 118$ dB
- ADC clipping point (0 dBFS) is absolute input power limit
 - ◆ ADC “crashes” if driven above 0 dBFS
- Typically, 0 dBFS ≈ -6 dBm
 - ◆ ADC noise floor = $-6 - 76 = -82$ dBm ($B = 0.5f_s = 40$ MHz)
- For $B = 2.4$ kHz (SSB), noise floor = $-82 + 42 = -124$ dBm
 - ◆ MDS (minimum discernible signal) = -124 dBm

The preselector and its role

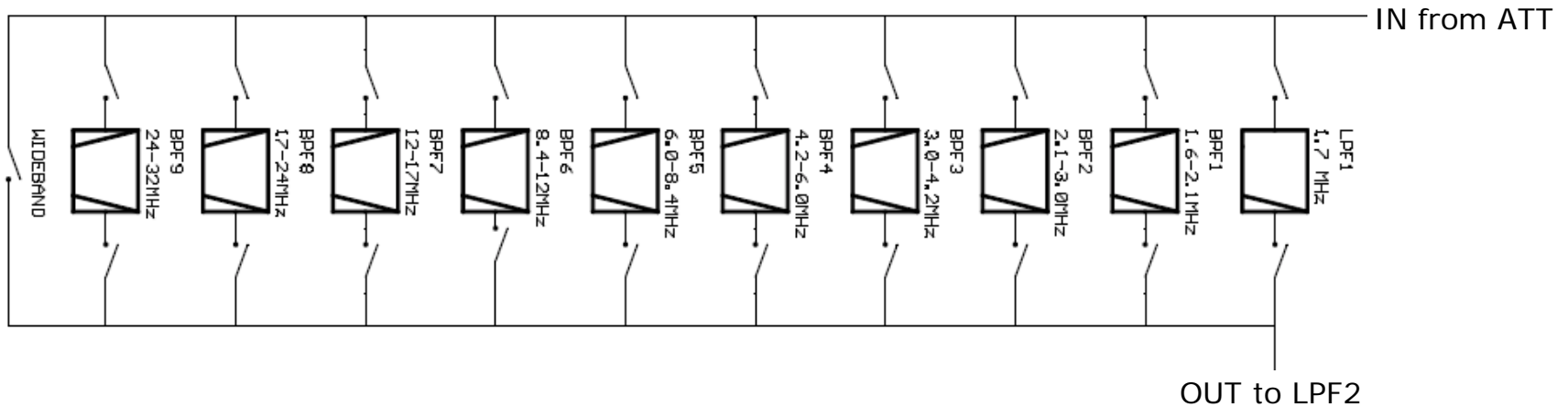

- The preselector narrows the RF bandwidth presented to the ADC.
- In wideband mode, e.g. for spectral analysis of entire HF range, the preselector is bypassed. This degrades IMD3 dynamic range by ≈ 3 dB, with a 2 dB improvement in MDS.
- IMD2 dynamic range is degraded in wideband mode. This is significant in areas (e.g. Europe) where HF broadcasters can drop IMD products into amateur bands.

RF preamp design considerations



- Even the best ADC's have a modest noise figure (NF).
 - ◆ LTC2206-14 in Perseus: NF = 16 dB. This is acceptable in HF range per [CCIR-670](#).

- A preamplifier is desirable for weak-signal reception, or when using limited antennas.
 - ◆ The preamp should have a somewhat lower NF than the ADC, together with moderate gain. Enabling the preamp should not degrade the blocking dynamic range (0 dBFS – MDS) by more than ≈ 4 dB.

- The preamp's 3rd-order intercept point (IP3) should be as high as possible, to minimize degradation of overall IMD3 dynamic range.

"Real-World Numbers"



■ From my lab:

- ◆ -123 dBm MDS @ 3.6 MHz, 2.4 kHz SSB, preselector off
 - ▶ Calculated value: -124 dBm
- ◆ -121 dBm MDS @ 3.6 MHz, 2.4 kHz SSB, preselector on
- ◆ AM sensitivity @ 3.9 MHz, 5 kHz filter: 1.3 μ V
 - ▶ For 10 dB (S+N/N), preselector on
- ◆ Reciprocal mixing noise RM > 107 dB !
 - ▶ RM = 113 dB @ 1 kHz offset (500 Hz CW filter)
 - RM is due mainly to ADC clock phase noise (slight contribution from ADC jitter)
- ◆ Filter shape factor (-6/-60 dB): \approx 1.09
- ◆ IMD3 dynamic range @ 2 kHz spacing \approx 100 dB !
 - ▶ Blocking dynamic range (500 Hz CW) 125 dB
 - ▶ Typical IMD2 dynamic range \approx 110 dB

■ *This outperforms most legacy receivers.*

IMD behaviour of ADC: there is no true "3rd-order intercept point"

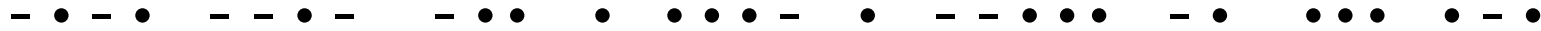

IP3 of typical ADC

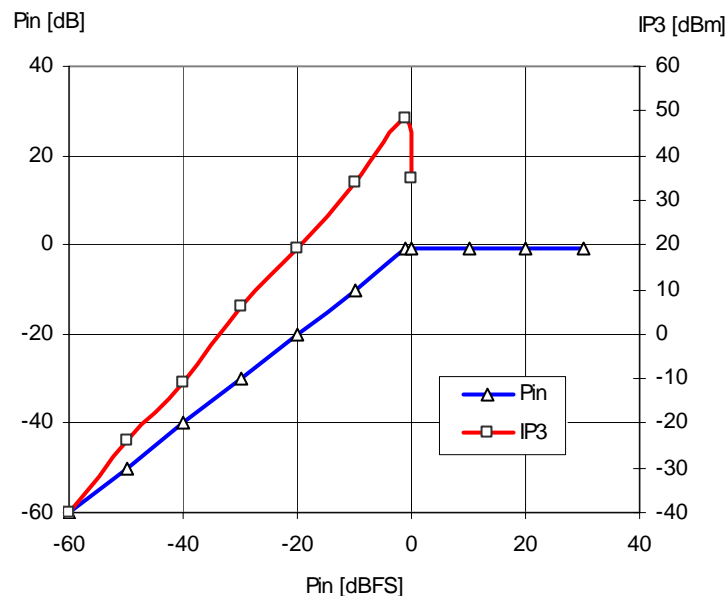

- In an ADC, the IMD3 product does not follow the 3rd-order law, and is essentially independent of signal amplitude. IMD degrades severely at 0 dBFS (ADC clipping point). Note that input power and IMD curves diverge, so there is no true intercept point.

The magic of dithering: a feature unique to the direct-sampling SDR



Measurement of IMD3 product with and without dithering

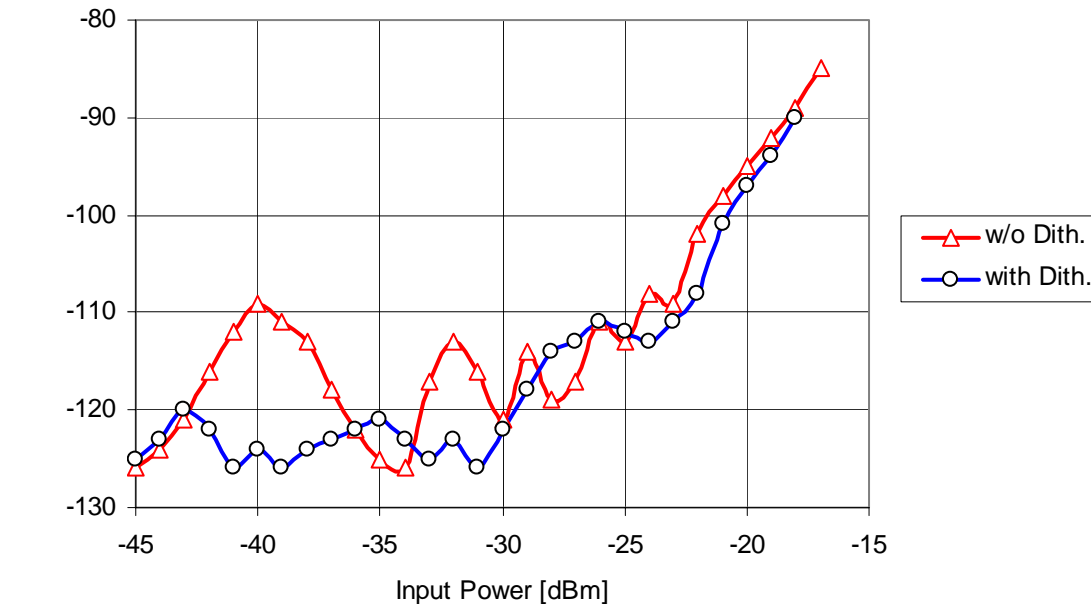

- Dithering is a very small amount of random noise (white noise), which is added to the ADC's analogue input before conversion. It randomly toggles the least significant bit, and has the effect of reducing IMD at the expense of a slight (1 – 2 dB) increase in noise floor.

PC interface

and baseband characteristics



- A USB 2.0 cable (480 Mbit/s) connects the Perseus to the PC.
- The Perseus output is a digital baseband with I and Q channels 90° apart, with zero frequency offset (“zero IF”).
- Output baseband width is selectable:
 - ◆ 100, 200, 400, 800 or 1600 kHz
- The PERSEUS software running on the PC performs all subsequent signal-processing and demodulation functions.
- The PC sound-card provides the DAC (digital/analogue converter) and audio amplifier driving the speakers.
- Thus, the choice of sound-card (integral, PCI or external) is *not* critical for Perseus performance.

Perseus software



- Downloadable from Perseus website:
<http://www.microtelecom.it/perseus/>
 - ◆ Current version: 4.0b.
- Perseus drivers also on website.
- Perseus also supports Winrad.
 - ◆ with ExtIO.dll for Winrad (also on website).
- 4.0b includes HFspan (wideband spectrum analyzer) and Perseus Server for remote operation.
 - ◆ 4.0b also includes user documentation & installation notes.
- Perseus software allows recording and playback of baseband streams. Playback displays entire screen live with audio, and allows “tuning” to select desired signal from recording.

Operational examples: Perseus in the lab

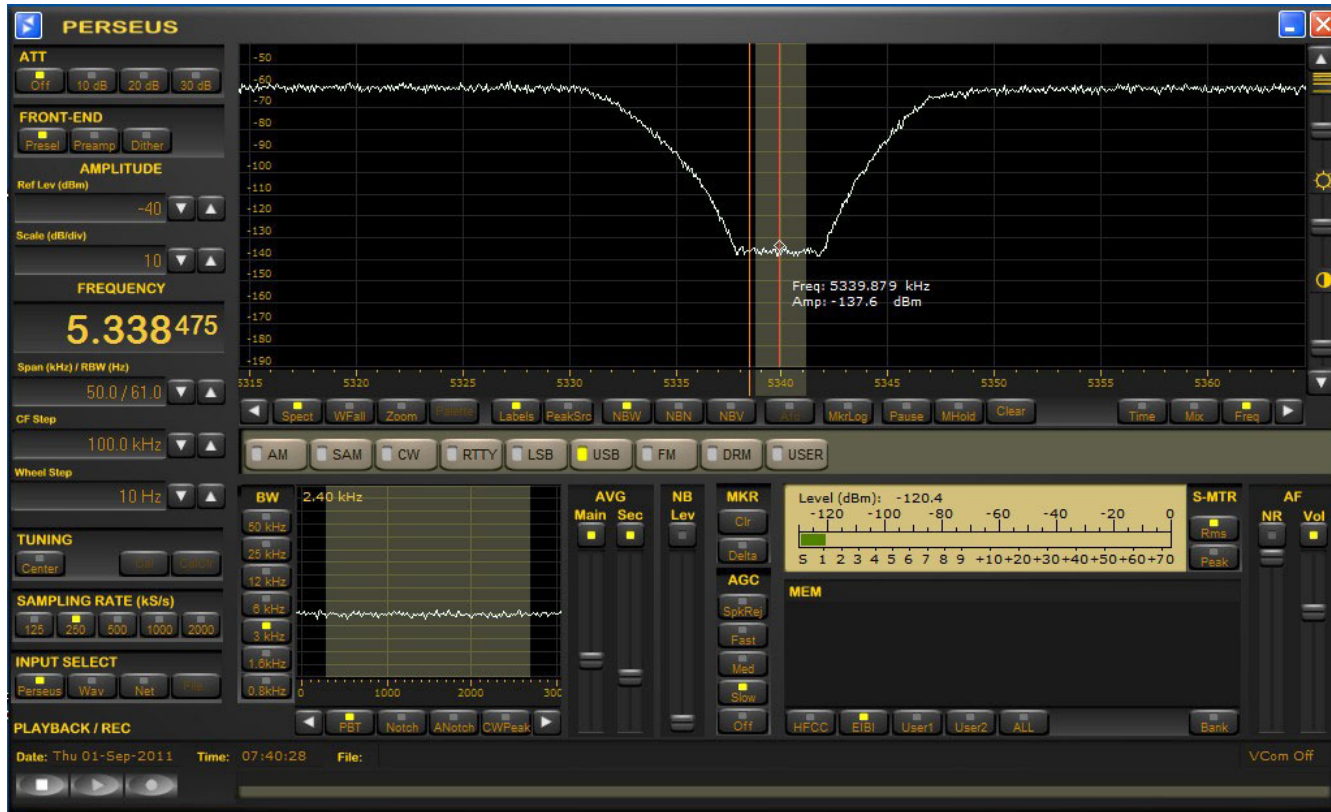

Perseus as a spectrum analyzer/power meter, displaying a notch filter stopband

Perseus on the MW AM band



On the MW broadcast band: listening to AM 680 kHz, displaying a ± 400 kHz span centred on 680 kHz. Span range: 400 Hz to 1.6 MHz. Minimum resolution bandwidth (RBW): 0.5 Hz.

On the ham bands



Playing back a recording made on 18.125 MHz USB. The entire screen, and the audio, are played back live.

HFSpan: a wideband spectrum scope

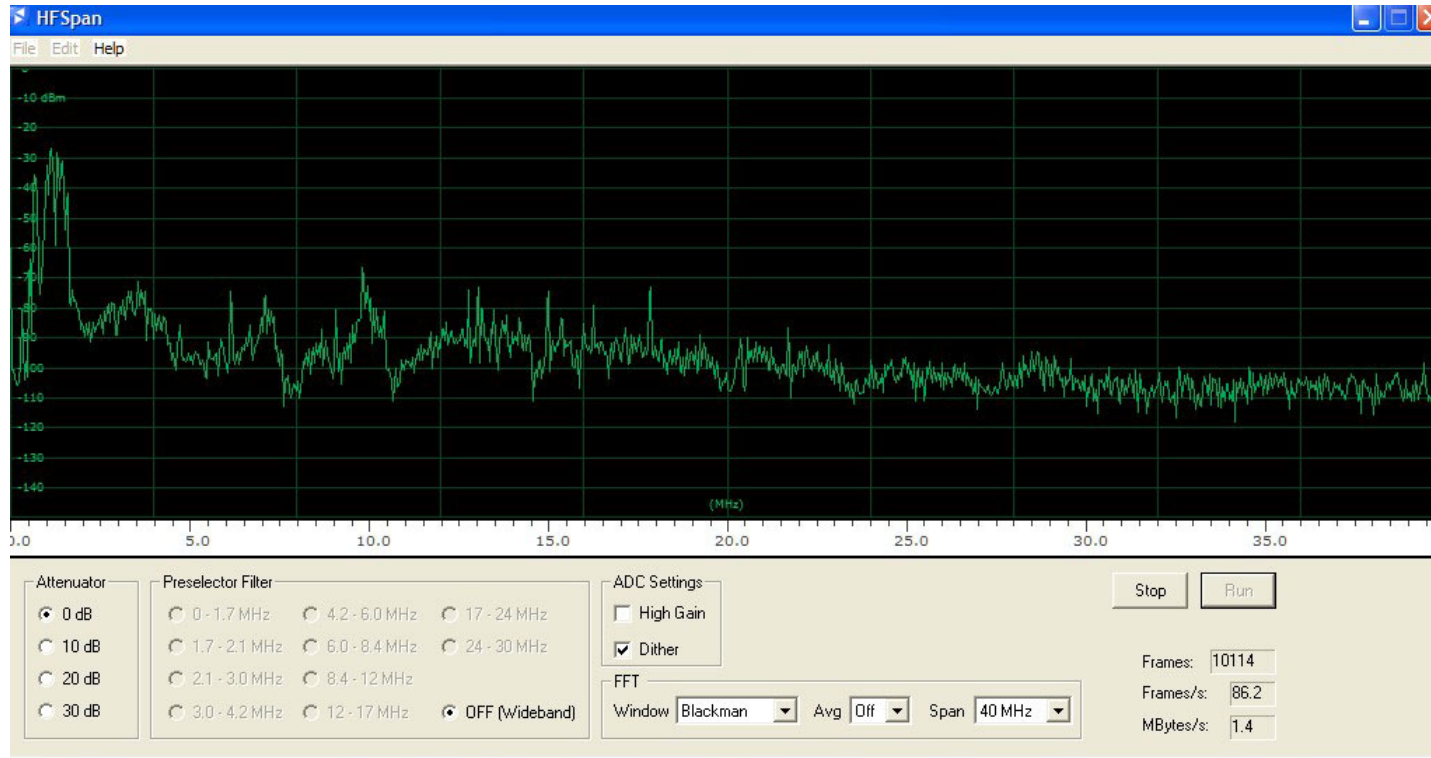

[RETURN](#)

HFspan is a simple wideband spectrum analyzer program for observation of the entire frequency range (0.1 kHz – 30 MHz).

Now for a live demo!

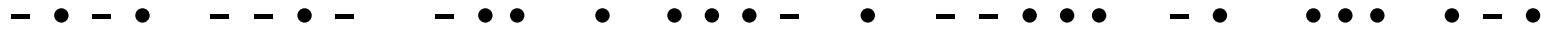

- **The Perseus display will be projected onto the auditorium screen.**

Thanks for watching!

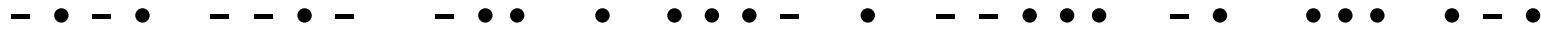

■ Links for further study:

- ◆ Perseus site: <http://www.microtelecom.it/perseus/>
- ◆ [Comparison of SDR and superhet RX](#)
- ◆ [Perseus with Linrad](#) by SM5BSZ